

Montageanleitung für Saunaholztür

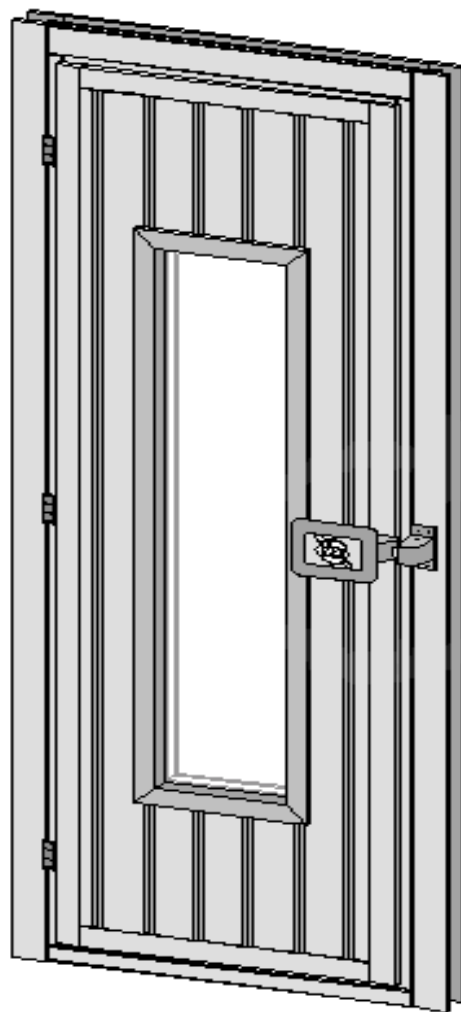





GB	Assembly instructions	Sauna door, wood
F	notice de montage	porte de sauna en bois
I	istruzioni di montaggio	porta per sauna, in legno
E	Instrucciones de montaje	Puerta de sauna, madera
P	Instruções de montagem	Porta da sauna, madeira
H	Szerelési utasítás	szauna üvegajtó számára





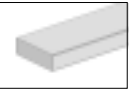

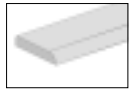







Art.-Nr. 520.0705.00.00

Stand: 522

D Stückliste											
GB	Parts list	F	Liste des pieces	E	Lista de piezas	I	Lista pezzi	P	Lista de pecas	H	Darabjegyzék

Pos	Bild	Land	Benennung	Land	Benennung	Abmessung [mm]	Anzahl [Stück]
①		D	Türrahmen	I	telaio della porta	618 x 1825	1
		GB	Door frame	E	Marco de puerta		
		F	cadre de porte	P	Caixilho da porta		
		H	Ajtókeret				
②		D	Saunatür, Holz	I	porta per sauna, in legno	574 x 1800	1
		GB	Sauna door, wood	E	Puerta de sauna, madera		
		F	porte de sauna en bois	P	Porta da sauna, madeira		
		H	Szauna ajtó, fa				
③		D	Falzleiste,	I	listello aggraffato,	15/45/1825	2
		GB	Rebate batten,	E	Listón plegador,		
		F	latte de feuillure,	P	Friso de encaixe,		
		H	Hornyos léc				
④		D	Falzleiste, quer	I	listello aggraffato, obliquo	15/45/648	1
		GB	Rebate batten, crosswise	E	Listón plegador, transversal		
		F	latte de feuillure, transversale	P	Friso de encaixe, transversal		
		H	Hornyos léc, kereszt				
⑤		D	Deckleiste	I	listello di copertura	11/58/1825	4
		GB	Ceiling batten	E	Listo tapajuntas		
		F	latte de recouvrement	P	Cobrejunta		
		H	Fedőléc				
⑥		D	Deckleiste	I	listello di copertura	11/58/740	2
		GB	Ceiling batten	E	Listo tapajuntas		
		F	latte de recouvrement	P	Cobrejunta		
		H	Fedőléc				
⑦		D	Saunatürgriff, innen	I	maniglia per porta da sauna, interna	40/90/45	1
		GB	Sauna door handle, interior	E	Manija puerta sauna, interior		
		F	poignée de porte de sauna intérieure	P	Manípulo da porta da sauna, interior		
		H	Szauna ajtó, belső				

Pos	Bild	Land	Benennung	Land	Benennung	Abmessung [mm]	Anzahl [Stück]
8		D	Saunaturgriff, außen	D	Saunaturgriff, außen	-	1
		GB	Sauna door handle, exterior	GB	Sauna door handle, exterior		
		F	poignée de porte de sauna extérieure	F	poignée de porte de sauna extérieure		
		H	Szauna ajtó, külső				
9		D	Griffeinsatz	I	inserto per maniglia	65/95/1	1
		GB	Handle insert	E	inserción		
		F	insert de poignée	P	Peça de punho		
		H	Fogantyú betét				
10		D	Rollverschluss	I	chiusura volante	-	1
		GB	Rolling lock	E	Cierre de rodadura		
		F	fermeture	P	Fecho de roletes		
		H	Görgös zár				
11		D	Einbohrband für Holztür	I	nastro di foratura per porta in legno	-	3
		GB	Spigot hinge for wooden door	E	Plantillas taladro puerta madera		
		F	paumelle à percer pour porte en bois	P	Dobradiça de perno roscado para porta de madeira		
		H	Beccavarható zsanér faajtó számára				
12		D	Halbrundkopfschraube	I	vite a testa tonda	5,0 x 40	4
		GB	Round head screw	E	Tornillo de cabeza semiesférica		
		F	vis à tête bombée	P	Parafuso de cabeça redonda cônica		
		H	Félgömbfejű csavar				
13		D	Halbrundkopfschraube	I	vite a testa tonda	2,5 x 16	2
		GB	Round head screw	E	Tornillo de cabeza semiesférica		
		F	vis à tête bombée	P	Parafuso de cabeça redonda cônica		
		H	Félgömbfejű csavar				
14		D	Schraube	I	vite	5,0 x 100	2
		GB	Screw	E	Tornillo		
		F	vis	P	Parafuso		
		H	Csavar				
15		D	Schraube	I	vite	4,5 x 70	2
		GB	Screw	E	Tornillo		
		F	vis	P	Parafuso		
		H	Csavar				

Pos	Bild	Land	Benennung	Land	Benennung	Abmessung [mm]	Anzahl [Stück]
16		D	Schraube	I	vite	4,0 x 60	9
		GB	Screw	E	Tornillo		
		F	vis	P	Parafuso		
		H	Csavar				
17		D	Schraube	I	vite	3,5 x 35	15
		GB	Screw	E	Tornillo		
		F	vis	P	Parafuso		
		H	Csavar				
18		D	Schraube	I	vite	5,0 x 80	6
		GB	Screw	E	Tornillo		
		F	vis	P	Parafuso		
		H	Csavar				
19		D	Drahtstift	I	spina in filo metallico	16 x 30	28
		GB	Wire nail	E	Punta de París		
		F	pointe	P	Prego de cabeça chata		
		H	Huzalszeg				

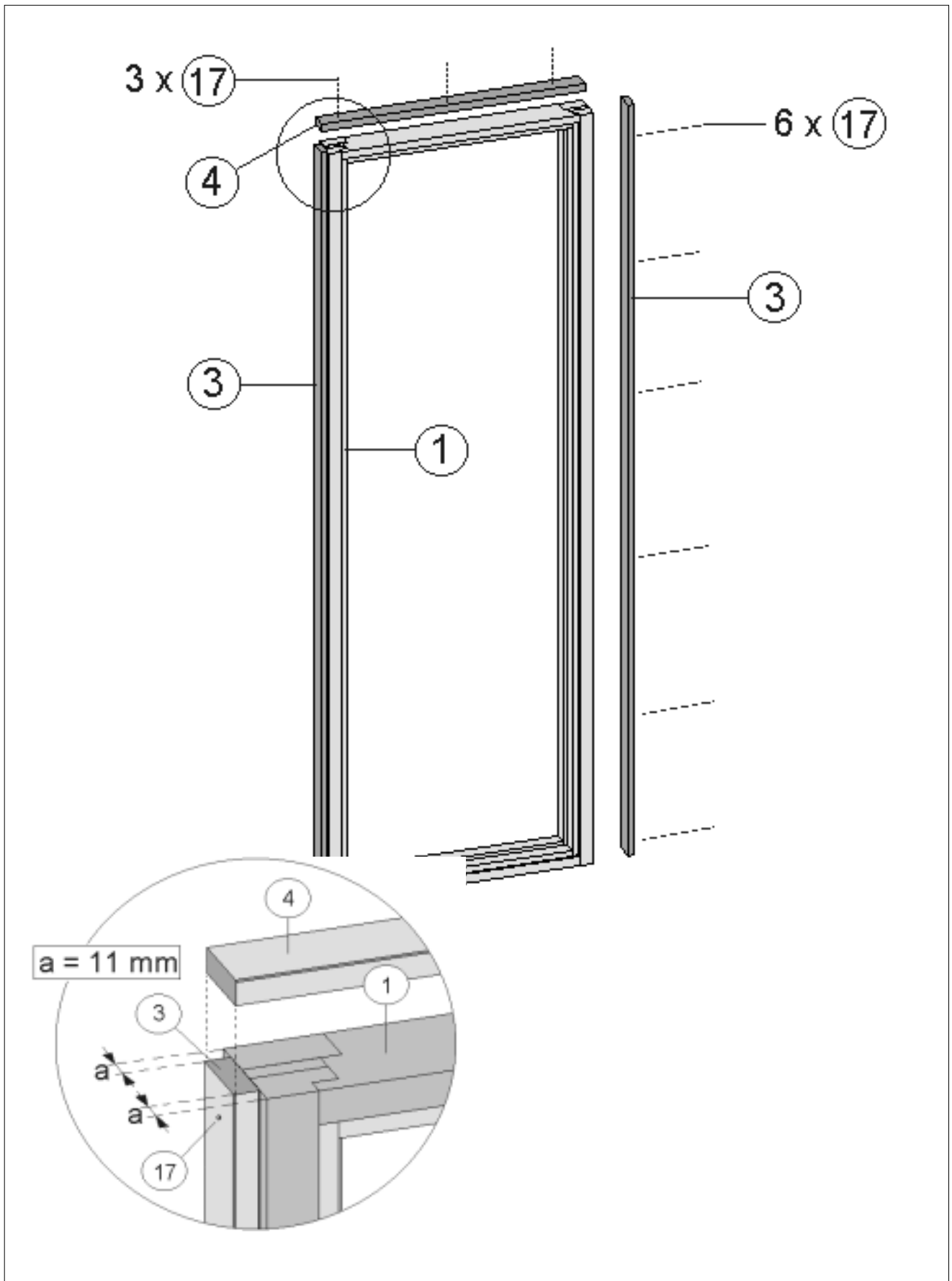
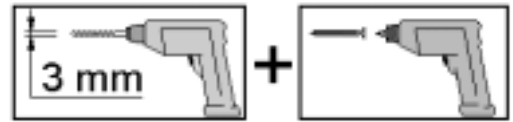

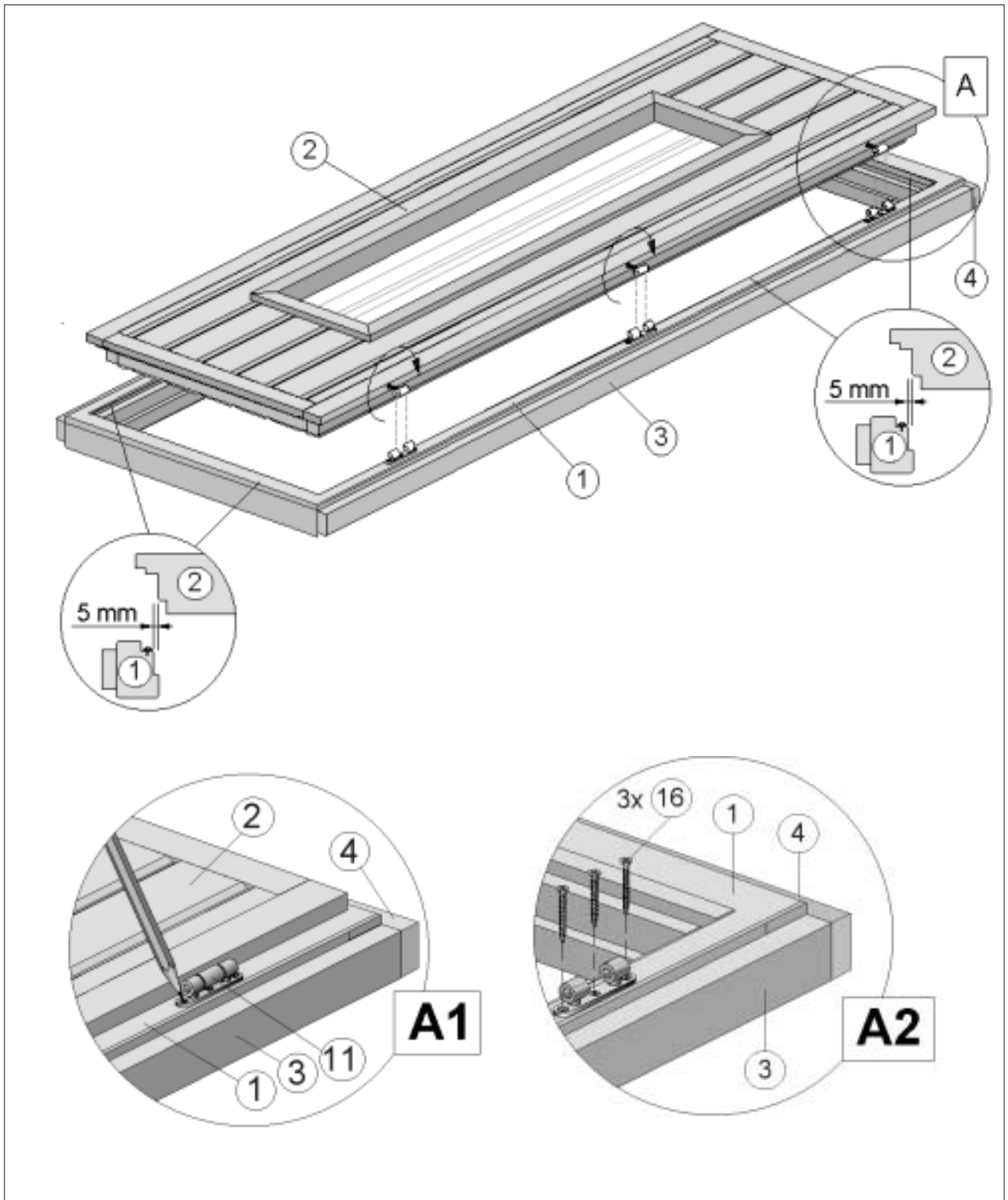
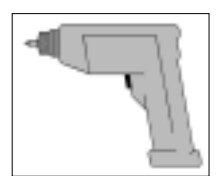
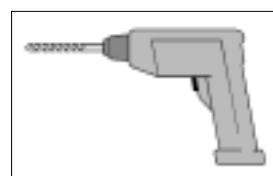
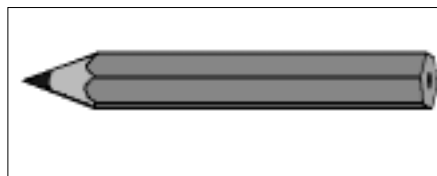
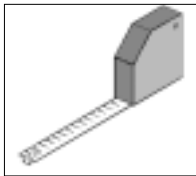

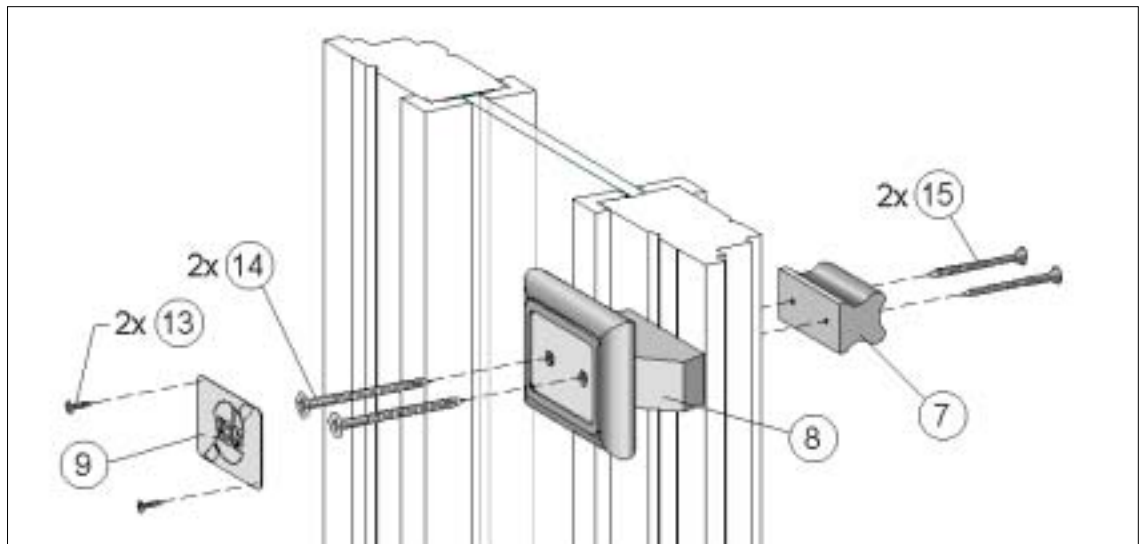
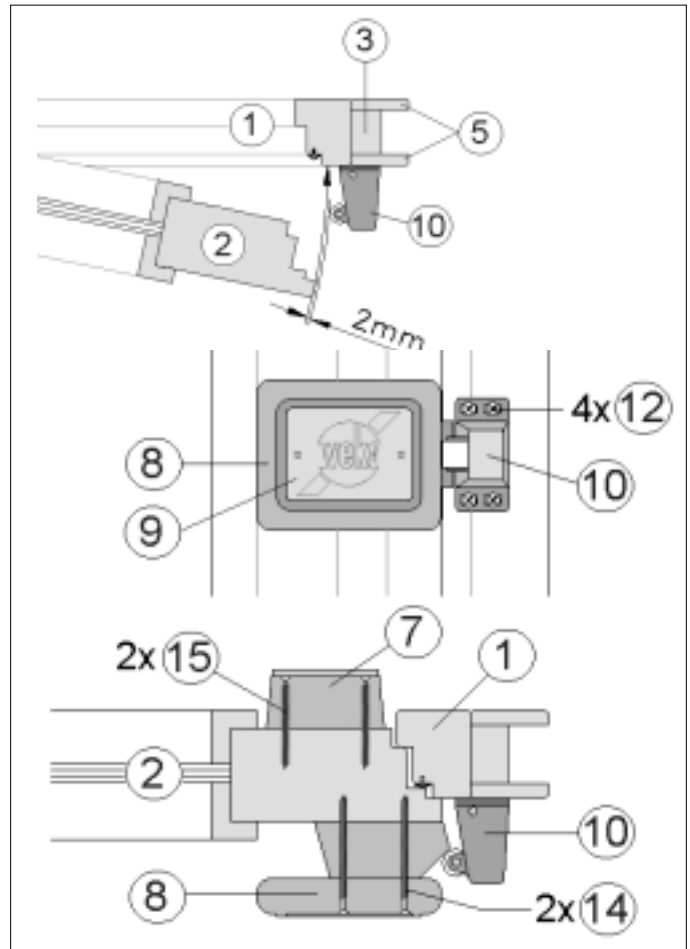
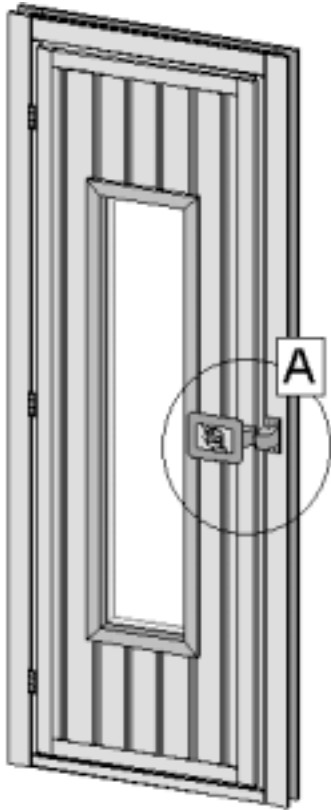
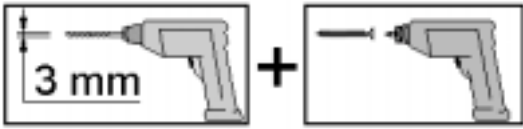
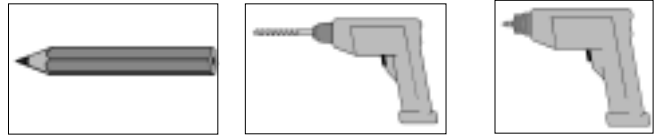

weka Holzbau GmbH, Johannesstr. 16
 D-17034 Neubrandenburg
 Tel.: 0395 42908-0
 Fax: 0395 42908-83

MA Art.-Nr.: 800.0286.02.17